



SF1601G- SF1608G

16.0AMPS. Glass Passivated Super Fast Rectifiers

TO-220AB

Features

- ◇ High efficiency, low VF
- ◇ High current capability
- ◇ High reliability
- ◇ High surge current capability
- ◇ Low power loss.
- ◇ For use in low voltage, high frequency inverter, free wheeling, and polarity protection application
- ◇ Green compound with suffix "G" on packing code & prefix "G" on datecode.

Mechanical Data

- ◇ Cases: TO-220AB Molded plastic
- ◇ Epoxy: UL 94V-0 rate flame retardant
- ◇ Terminals: Pure tin plated, lead free, solderable per MIL-STD-202, Method 208 guaranteed
- ◇ Polarity: As marked
- ◇ High temperature soldering guaranteed:
260°C/10 seconds 16" (4.06mm) from case.
- ◇ Weight: 1.90 grams

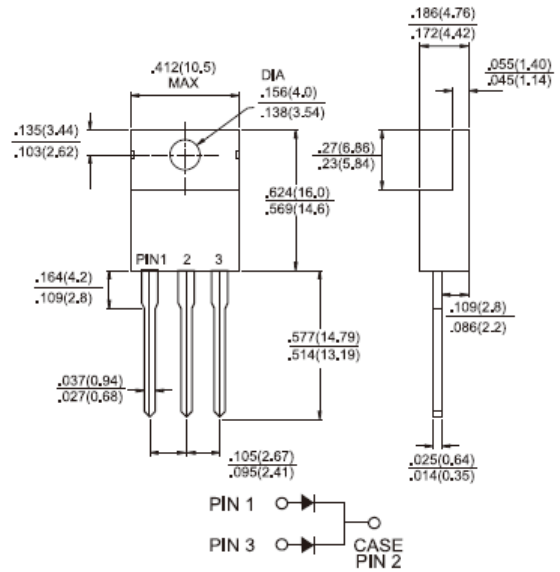

Dimensions in inches and (millimeters)

Marking Diagram

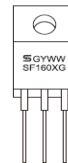

- SF160X(= Specific Device Code
- G = Green Compound
- Y = Year
- WW = Work Week

Maximum Ratings and Electrical Characteristics

Rating at 25 °C ambient temperature unless otherwise specified.

Single phase, half wave, 60 Hz, resistive or inductive load.

For capacitive load, derate current by 20%

Type Number	Symbol	SF 1601G	SF 1602G	SF 1603G	SF 1604G	SF 1605G	SF 1606G	SF 1607G	SF 1608G	Units
Maximum Recurrent Peak Reverse Voltage	V_{RRM}	50	100	150	200	300	400	500	600	V
Maximum RMS Voltage	V_{RMS}	35	70	105	140	210	280	350	420	V
Maximum DC Blocking Voltage	V_{DC}	50	100	150	200	300	400	500	600	V
Maximum Average Forward Rectified Current	$I_{F(AV)}$	16								A
Peak Forward Surge Current, 8.3 ms Single Half Sine-wave Superimposed on Rated Load (JEDEC method)	I_{FSM}	125								A
Maximum Instantaneous Forward Voltage (Note 1) @ 8 A	V_F	0.975				1.3		1.7		V
Maximum DC Reverse Current @ $T_A=25\text{ }^\circ\text{C}$ at Rated DC Blocking Voltage @ $T_A=100\text{ }^\circ\text{C}$	I_R	10				400				μA
Maximum Reverse Recovery Time (Note 2)	T_{rr}	35								nS
Typical Junction Capacitance (Note 3)	C_j	80				60				pF
Typical Thermal Resistance	$R_{\theta JC}$	1.5								$^\circ\text{C/W}$
Operating Temperature Range	T_J	- 65 to + 150								$^\circ\text{C}$
Storage Temperature Range	T_{STG}	- 65 to + 150								$^\circ\text{C}$

Note 1: Pulse Test with PW=300 usec, 1% Duty Cycle

Note 2: Reverse Recovery Test Conditions: $I_F=0.5\text{A}$, $I_R=1.0\text{A}$, $I_{RR}=0.25\text{A}$.

Note 3: Measured at 1 MHz and Applied Reverse Voltage of 4.0V D.C.

RATINGS AND CHARACTERISTIC CURVES (SF1601G THRU SF1608G)

FIG. 1- MAXIMUM FORWARD CURRENT DERATING CURVE

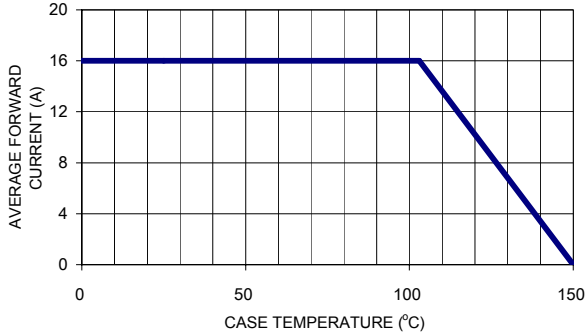

FIG. 2- TYPICAL REVERSE CHARACTERISTICS

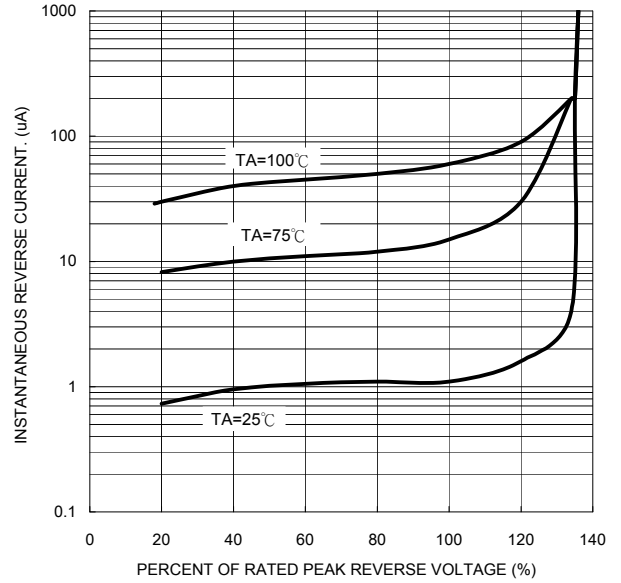

FIG. 3- MAXIMUM NON-REPETITIVE FORWARD SURGE CURRENT PER LEG

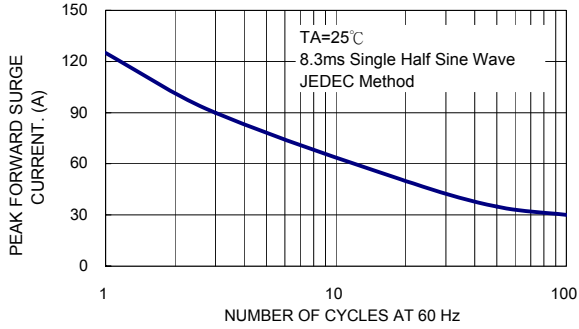

FIG. 5- TYPICAL FORWARD CHARACTERISTICS PER LEG

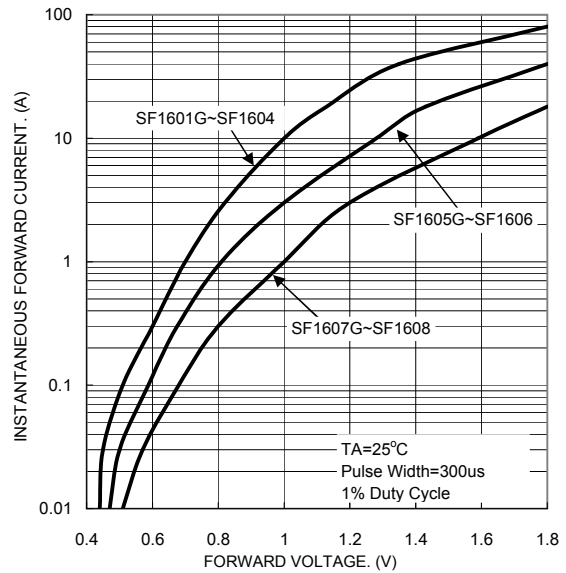

FIG. 4- TYPICAL JUNCTION CAPACITANCE PER LEG

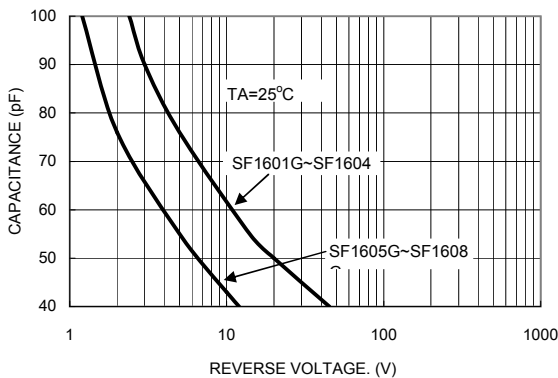

FIG. 6- REVERSE RECOVERY TIME CHARACTERISTIC AND TEST CIRCUIT DIAGRAM

